

CHANGE HISTORY TABLE

No	Rev.	Modification description	Date	Initials
1.	01	Initial Release	03-02-2014	EM
2.				
3.				
4.				

2-2

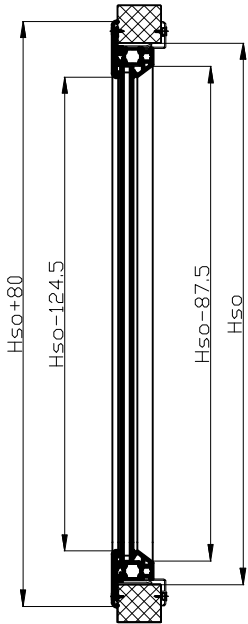

2

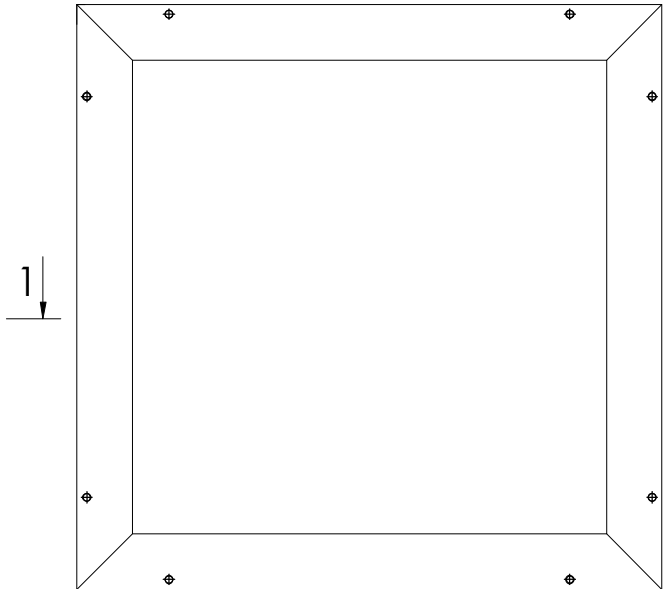

2

1-1

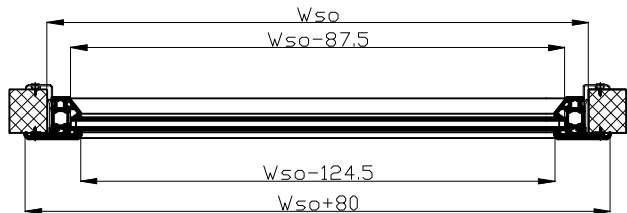

Profile P68 A=55-115mm	Profile P60 A=115-135mm	Profile P72 A=135-200mm

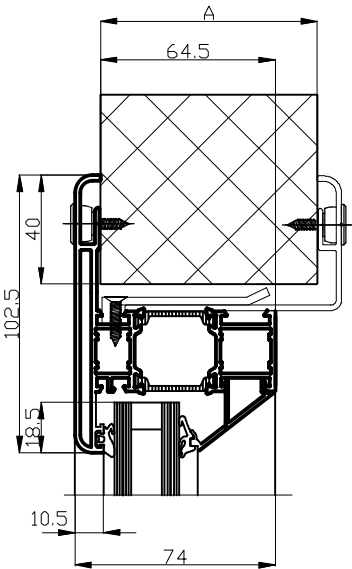

Contact address:
THERMOD AB
 Söderborgsvägen 32
 SE-671 95 Klässbol, Sweden
 tel. (0)570 72 74 70
 fax. (0)570 72 74 71
 info@thermod.se

Drawing name:
**window, two sided cover,
 mounting for panel, glass
 20-26mm**
 Date: 03-02-2014
 Drawn by: E.Malczak

Drawing number:
000-003-00
 Scale: 1:10
 Print format: A3
 Revision: 01

CHANGE HISTORY TABLE

No	Rev.	Modification description	Date	Initials
1.	01	Initial Release	03-02-2014	EM
2.				
3.				
4.				

2-2

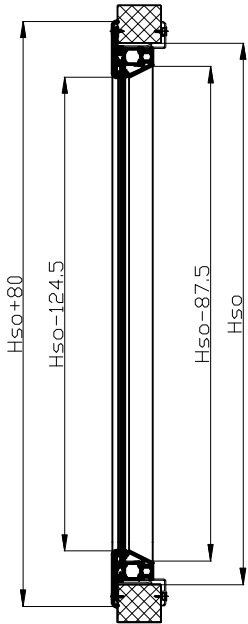

2

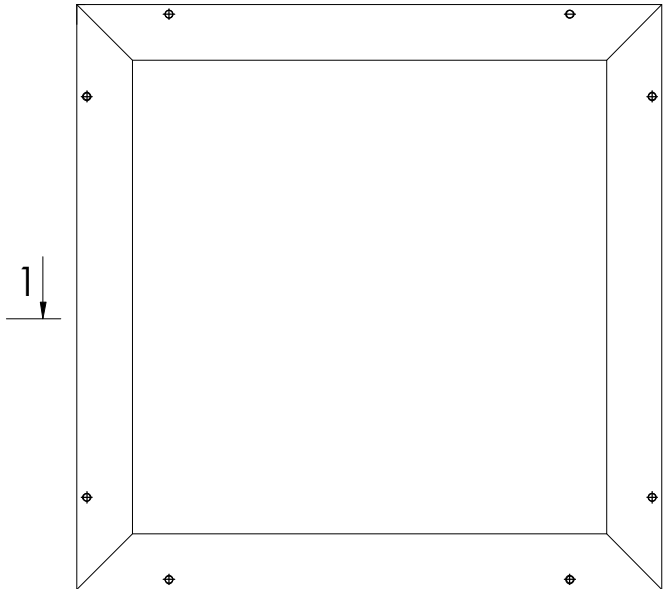

2

1-1

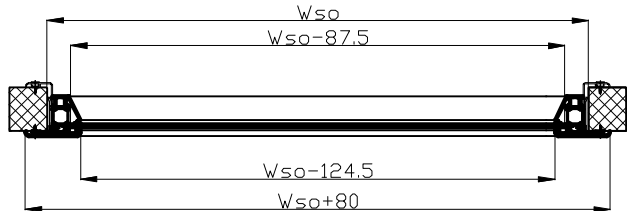

Profile P68 A=55-115mm	Profile P60 A=115-135mm	Profile P72 A=135-200mm

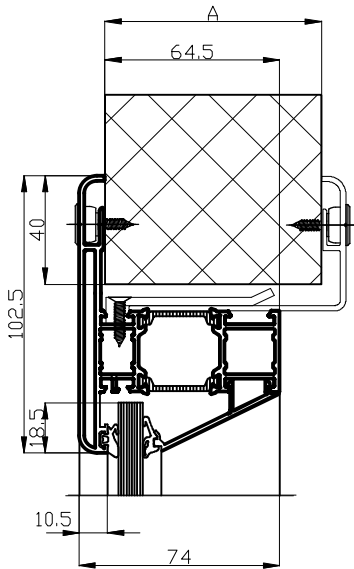

Contact address:
THERMOD AB
 Söderborgsvägen 32
 SE-671 95 Klässbol, Sweden
 tel. (0)570 72 74 70
 fax. (0)570 72 74 71
 info@thermod.se

Drawing name:
**window, two sided cover,
 mounting for panel,glass
 5-11mm**
 Date: 03-02-2014
 Drawn by: E.Malczak

Drawing number:
000-004-00
 Scale: 1:10
 Print format: A3
 Revision: 01

CHANGE HISTORY TABLE

No	Rev.	Modification description	Date	Initials
1.	01	Initial Release	03-02-2014	EM
2.				
3.				
4.				

2-2

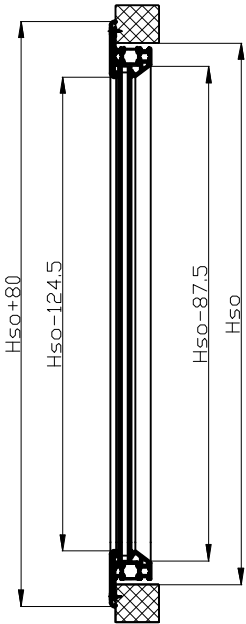

2

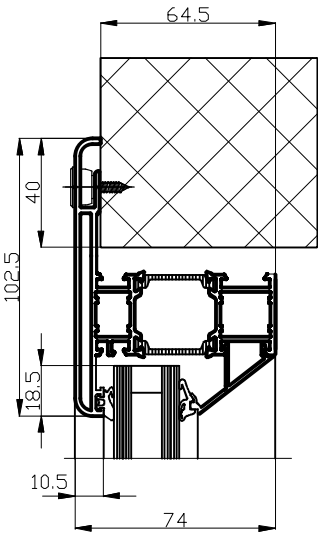
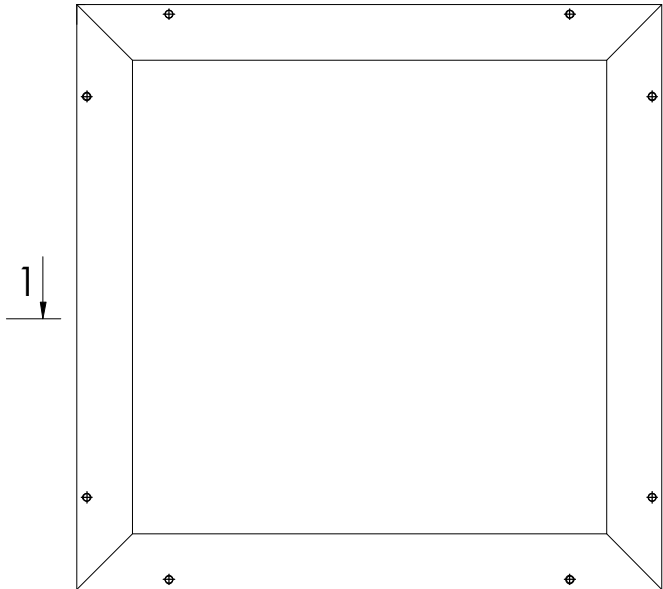

2

1-1

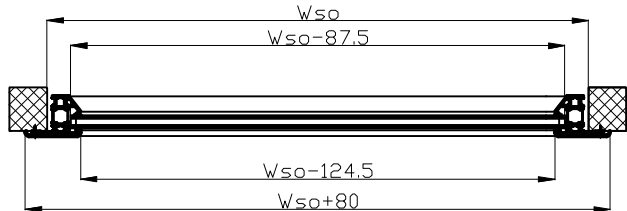

Contact address:
THERMOD AB
 Söderborgsvägen 32
 SE-671 95 Klässbol, Sweden
 tel. (0)570 72 74 70
 fax. (0)570 72 74 71
 info@thermod.se

Drawing name:
**window, one sided cover,
 mounting for panel, glass
 20-26mm**
 Date: 03-02-2014
 Drawn by: E.Malczak

Drawing number:
000-001-00
 Scale: 1:10
 Print format: A3
 Revision: 01

CHANGE HISTORY TABLE

No	Rev.	Modification description	Date	Initials
1.	01	Initial Release	03-02-2014	EM
2.				
3.				
4.				

2-2

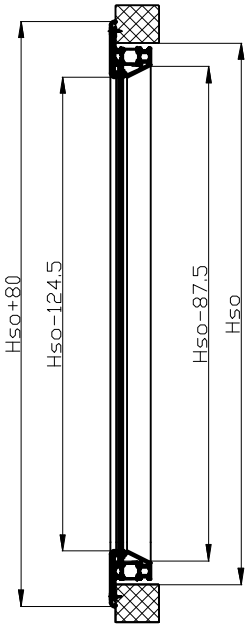

2

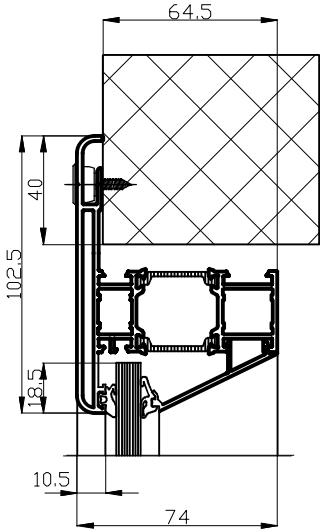
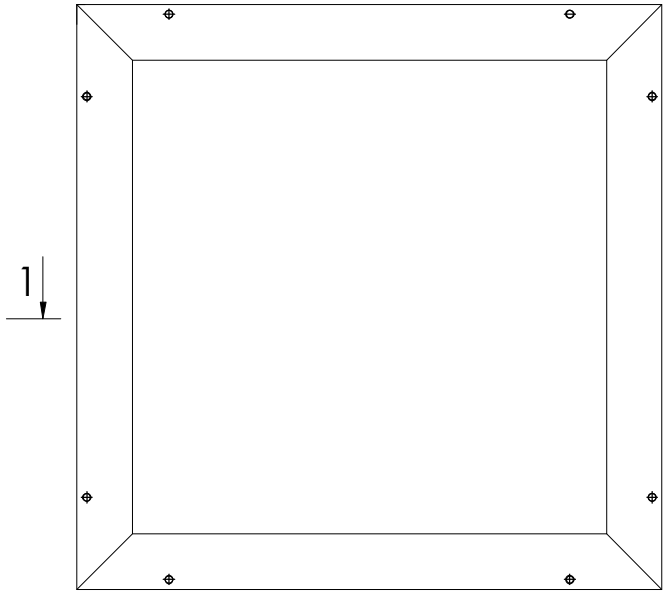

2

1-1

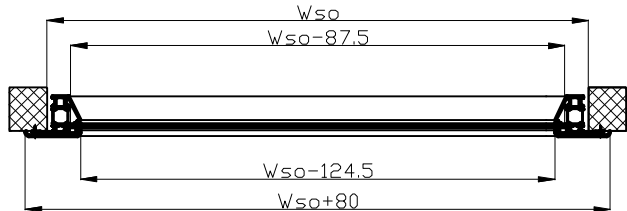

Contact address:
THERMOD AB
 Söderborgsvägen 32
 SE-671 95 Klässbol, Sweden
 tel. (0)570 72 74 70
 fax. (0)570 72 74 71
 info@thermod.se

Drawing name:
**window, one sided cover,
 mounting for panel,glass
 5-11mm**
 Date: 03-02-2014
 Drawn by: E.Malczak
 Scale: 1:10

Drawing number:
000-002-00
 Print format: A3
 Revision: 01

CHANGE HISTORY TABLE

No	Rev.	Modification description	Date	Initials
1.	01	Initial Release	03-02-2014	EM
2.				
3.				
4.				

2-2

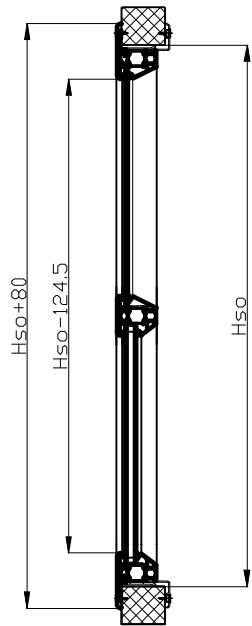

2

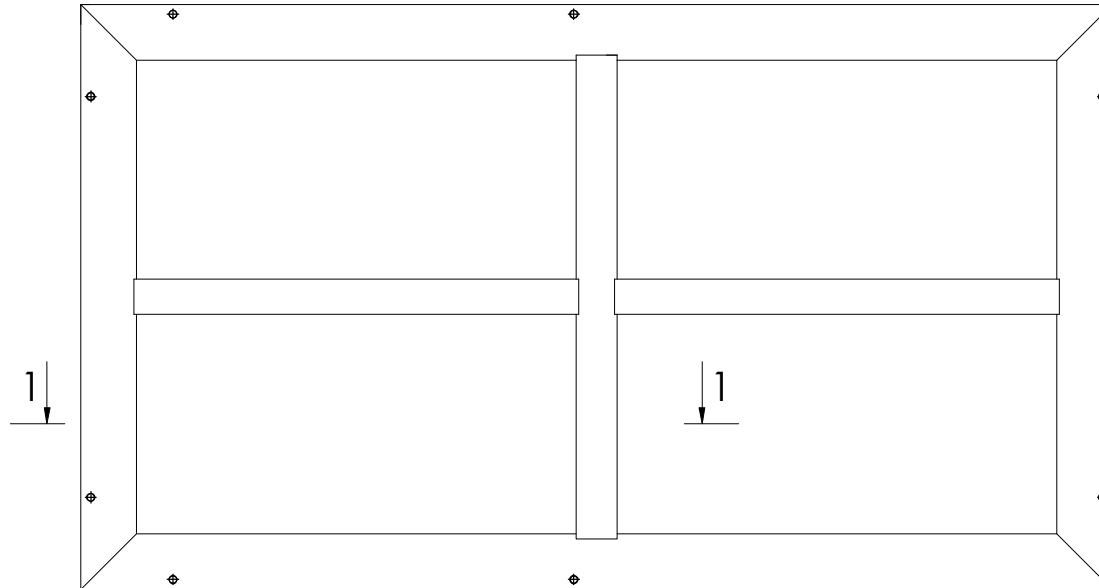

1

1

2

1-1

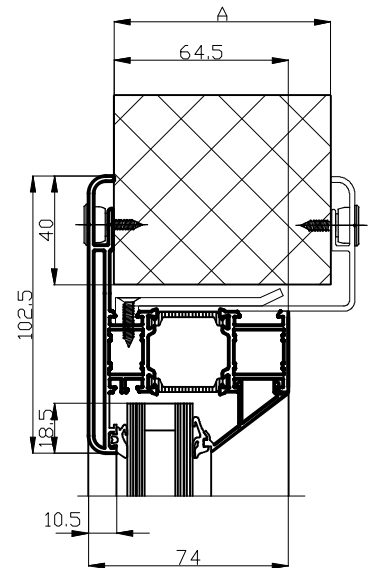
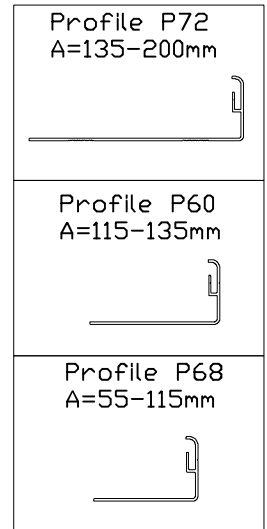
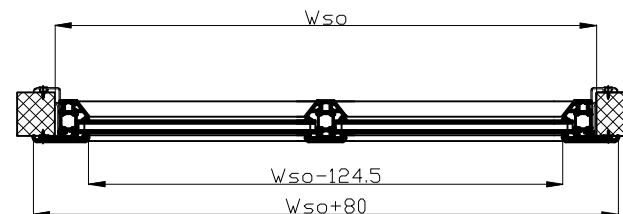

Contact address:
THERMOD AB
Söderborgsvägen 32
SE-671 95 Klässbol, Sweden
tel. (0)570 72 74 70
fax. (0)570 72 74 71
info@thermod.se

Drawing name:
window, two sided cover,
mounting for panel, glass
20-26mm

Date: 03-02-2014
Drawn by: E.Malczak
Scale: 1:10
Print format: A3
Revision: 01

Drawing number:
000-005-00