

CHANGE HISTORY TABLE

| No | Rev. | Modification description | Date       | Initials |
|----|------|--------------------------|------------|----------|
| 1. | 01   | Initial Release          | 30-08-2013 | AD       |
| 2. | 02   | Drawing Update           | 08-10-2013 | AD       |
| 3. |      |                          |            |          |

2-2

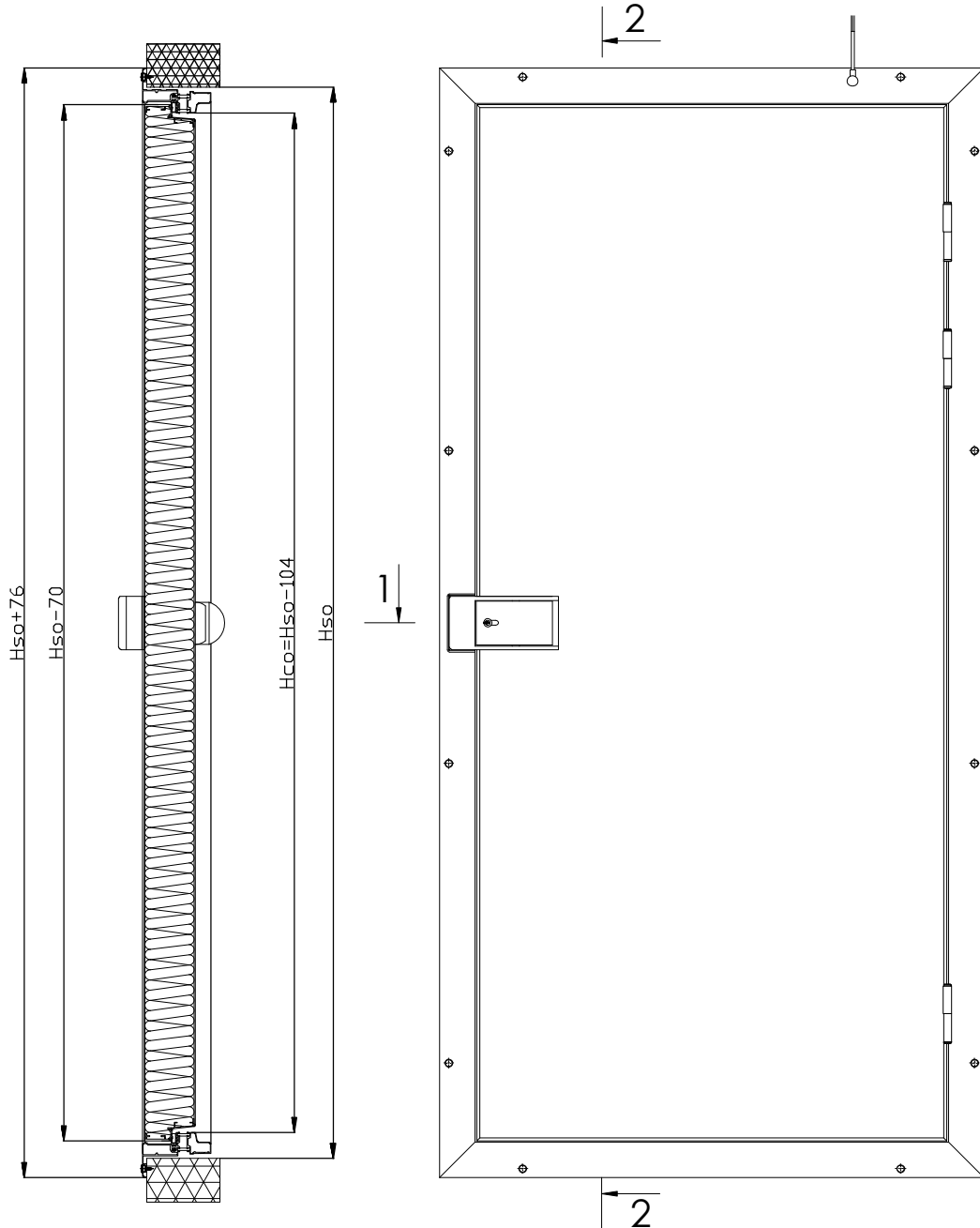

1-1

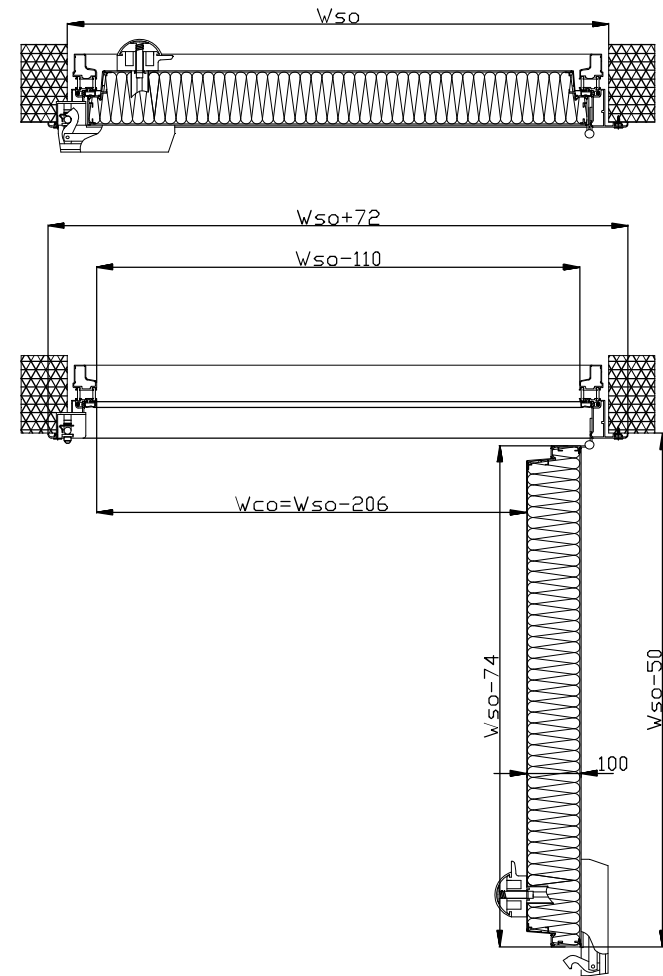

Contact address:  
**THERMOD AB**  
 Söderborgsvägen 32  
 SE-671 95 Klässbol, Sweden  
 tel. (0)570 72 74 70  
 fax. (0)570 72 74 71  
 info@thermod.se

Drawing name:  
**FD, one sided cover,  
 mounting for panel, 4 side  
 frame**  
 Date: 08-10-2013  
 Drawn by: A.DZIEWALTOWSKI  
 Scale: 1:10

Drawing number:  
**030-030-00**  
 Print format: A3  
 Revision: 02

CHANGE HISTORY TABLE

| No | Rev. | Modification description | Date       | Initials |
|----|------|--------------------------|------------|----------|
| 1. | 01   | Initial Release          | 30-08-2013 | AD       |
| 2. | 02   | Drawing Update           | 08-10-2013 | AD       |
| 3. |      |                          |            |          |

2-2

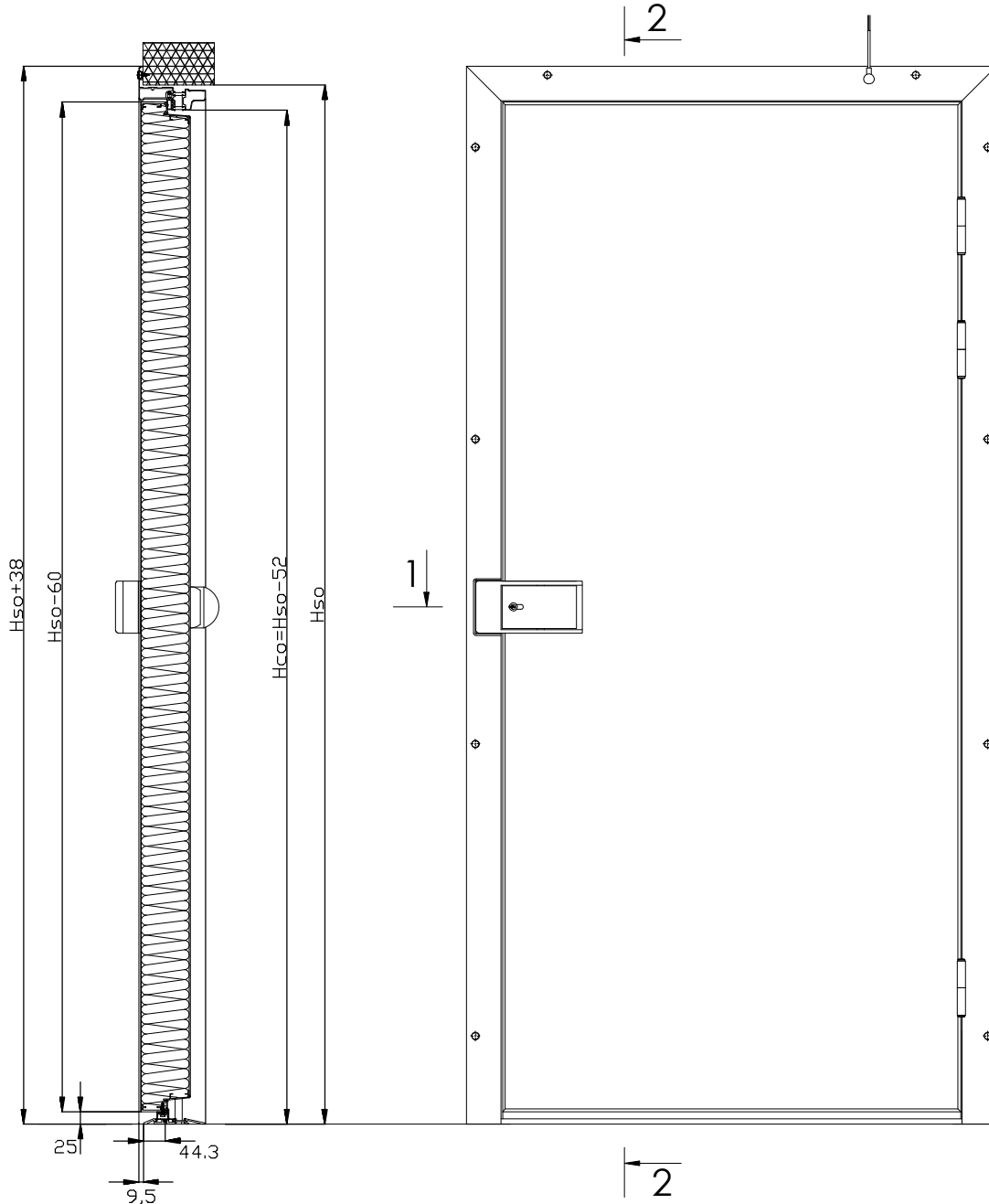

1-1

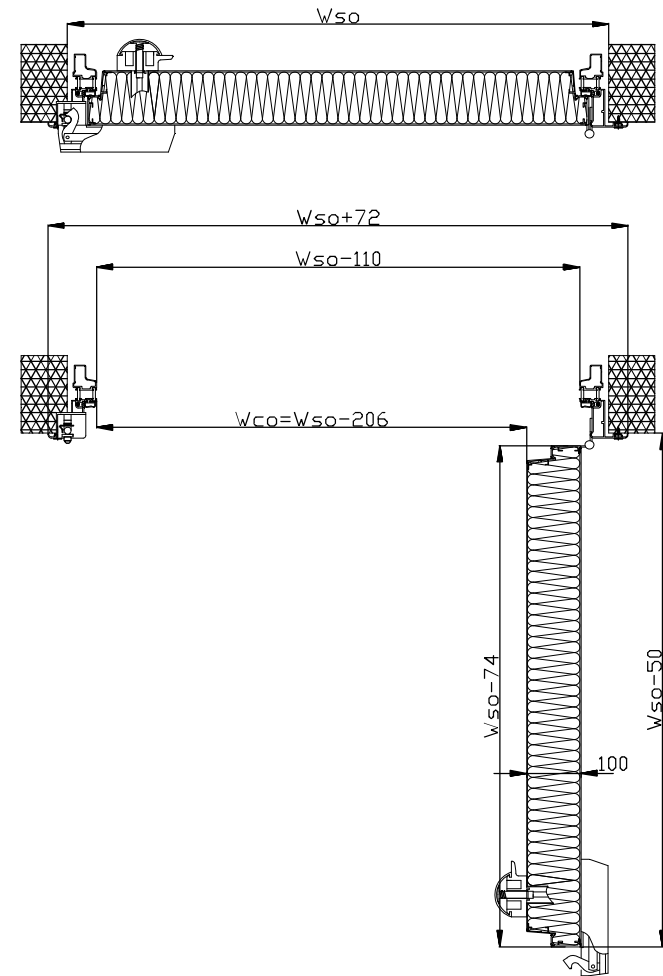

Contact address:  
**THERMOD AB**  
 Söderborgsvägen 32  
 SE-671 95 Klässbol, Sweden  
 tel. (0)570 72 74 70  
 fax. (0)570 72 74 71  
 info@thermod.se

Drawing name:  
**FD, one sided cover,  
 mounting for panel,**

Drawing number:  
**030-012-00**

|                            |                              |                       |                            |                        |
|----------------------------|------------------------------|-----------------------|----------------------------|------------------------|
| Date:<br><b>08-10-2013</b> | Drawn by:<br>A.DZIEWALTOWSKI | Scale:<br><b>1:10</b> | Print format:<br><b>A3</b> | Revision:<br><b>02</b> |
|----------------------------|------------------------------|-----------------------|----------------------------|------------------------|

CHANGE HISTORY TABLE

| No | Rev. | Modification description | Date       | Initials |
|----|------|--------------------------|------------|----------|
| 1. | 01   | Initial Release          | 30-08-2013 | AD       |
| 2. | 02   | Drawing Update           | 08-10-2013 | AD       |
| 3. |      |                          |            |          |

2-2

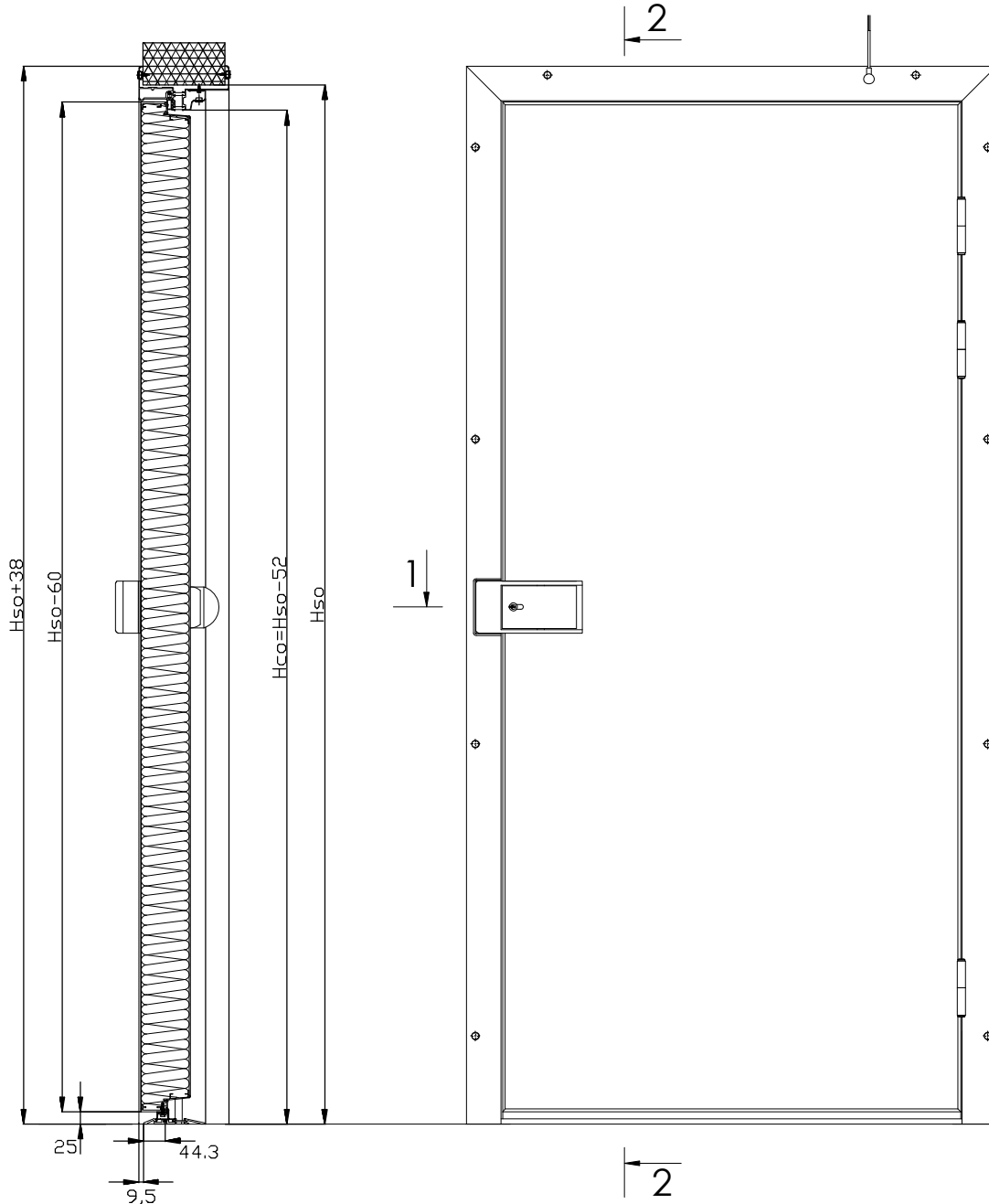

1-1

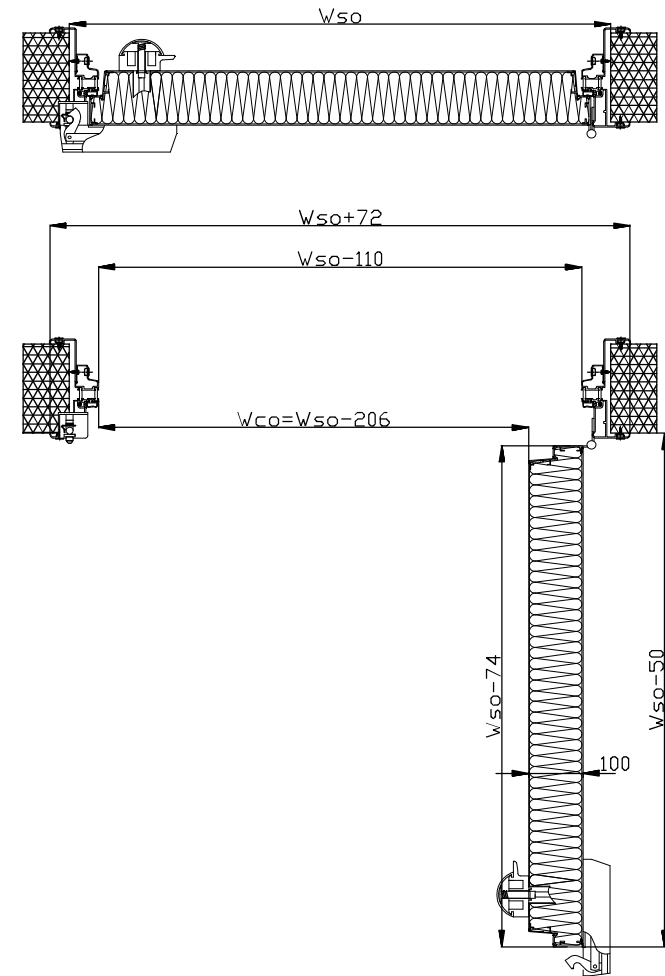

Contact address:  
**THERMOD AB**  
 Söderborgsvägen 32  
 SE-671 95 Klässbol, Sweden  
 tel. (0)570 72 74 70  
 fax. (0)570 72 74 71  
 info@thermod.se

Drawing name:  
**FD, two sided cover (N2),  
 mounting for panel,**

Drawing number:  
**030-013-00**

Date:  
**08-10-2013**

Drawn by:  
**A.DZIEWIALTOWSKI**

Scale:  
**1:10**

Print format: **A3**  
 Revision: **02**

CHANGE HISTORY TABLE

| No | Rev. | Modification description | Date       | Initials |
|----|------|--------------------------|------------|----------|
| 1. | 01   | Initial Release          | 30-08-2013 | AD       |
| 2. | 02   | Drawing Update           | 08-10-2013 | AD       |
| 3. |      |                          |            |          |

2-2

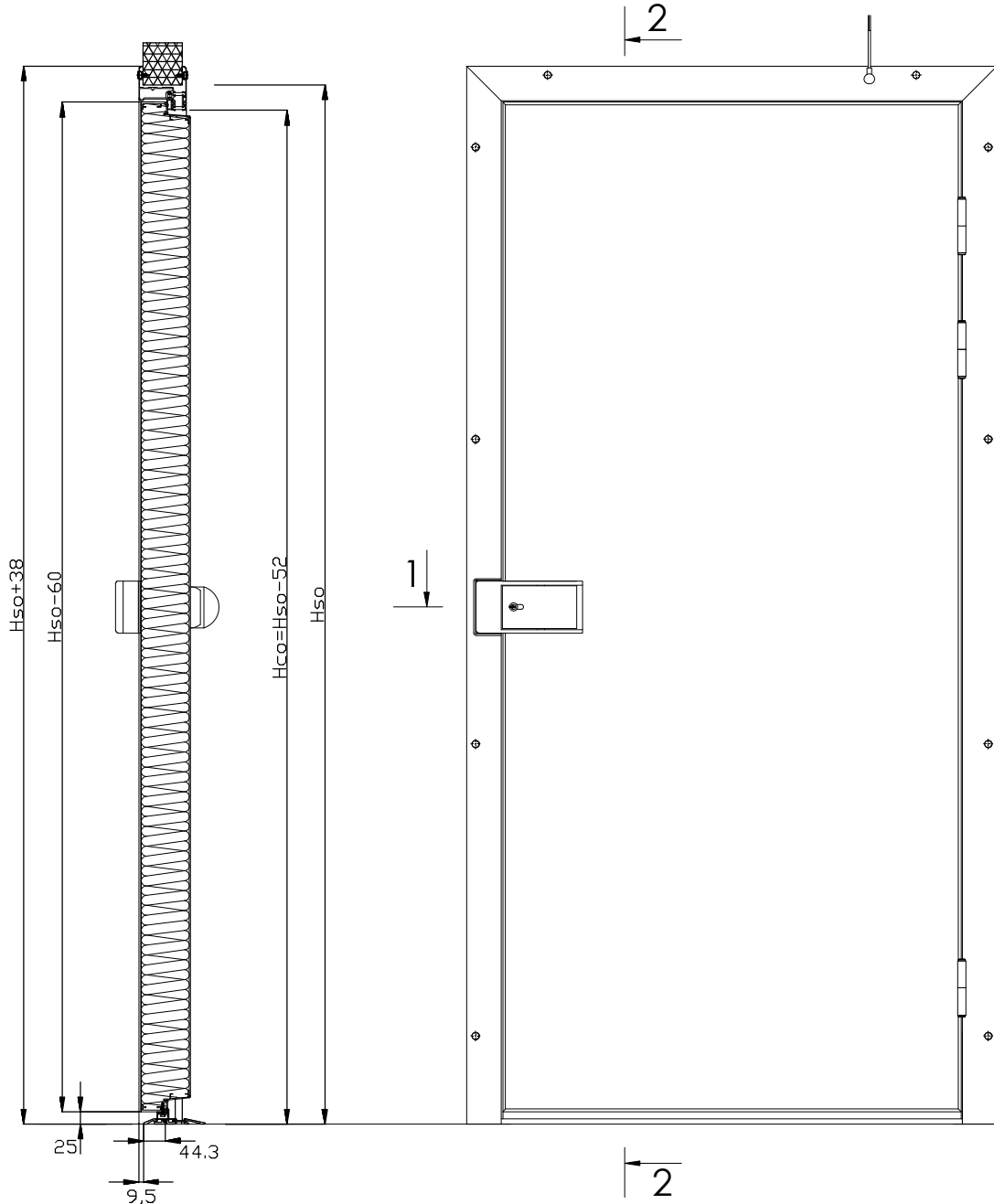

1-1

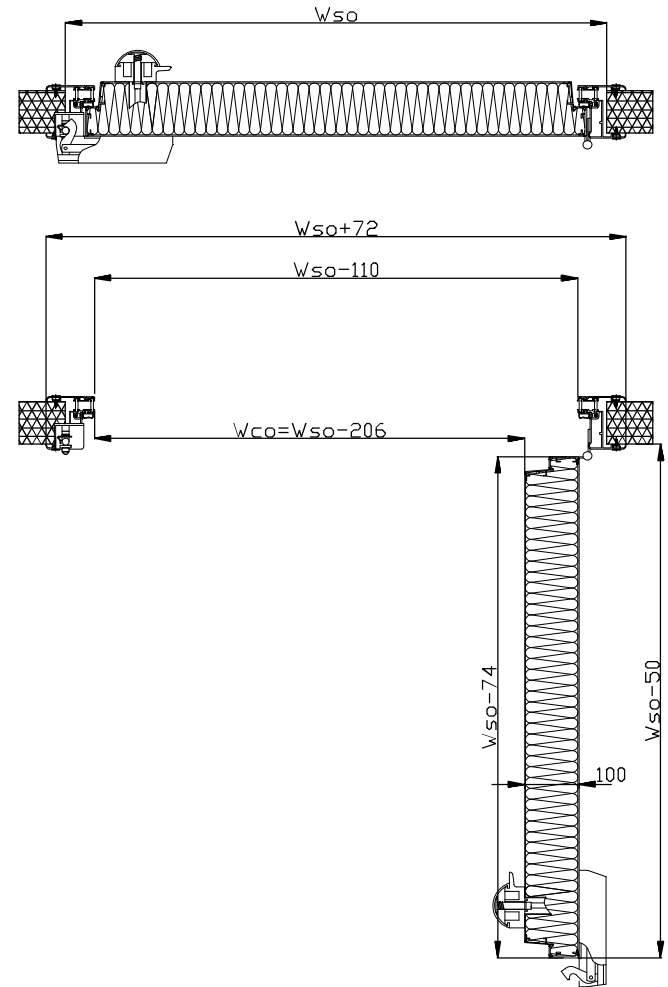

Contact address:  
**THERMOD AB**  
 Söderborgsvägen 32  
 SE-671 95 Klässbol, Sweden  
 tel. (0)570 72 74 70  
 fax. (0)570 72 74 71  
 info@thermod.se

Drawing name:  
**FD, two sided cover (N1),  
 mounting for panel,**

Drawing number:  
**030-014-00**

|                            |                               |                       |                            |                        |
|----------------------------|-------------------------------|-----------------------|----------------------------|------------------------|
| Date:<br><b>08-10-2013</b> | Drawn by:<br>A.DZIEWIALTOWSKI | Scale:<br><b>1:10</b> | Print format:<br><b>A3</b> | Revision:<br><b>02</b> |
|----------------------------|-------------------------------|-----------------------|----------------------------|------------------------|

CHANGE HISTORY TABLE

| No | Rev. | Modification description | Date       | Initials |
|----|------|--------------------------|------------|----------|
| 1. | 01   | Initial Release          | 26-01-2015 | AD       |
| 2. | 02   | Connecting box replaced  | 16-02-2015 | SK       |
| 3. | 03   | Connecting box replaced  | 03-03-2015 | SK       |

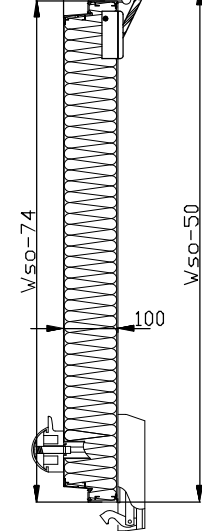
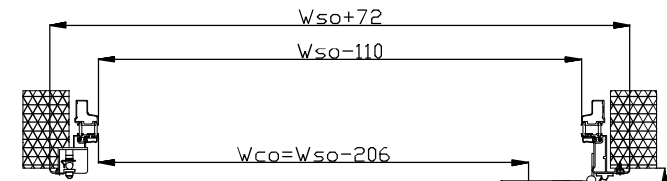
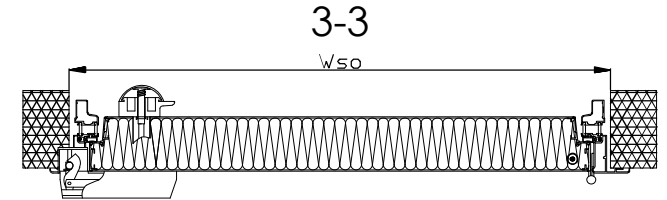
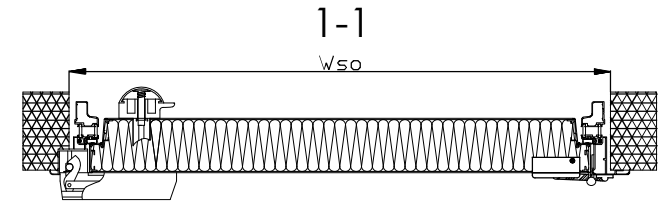
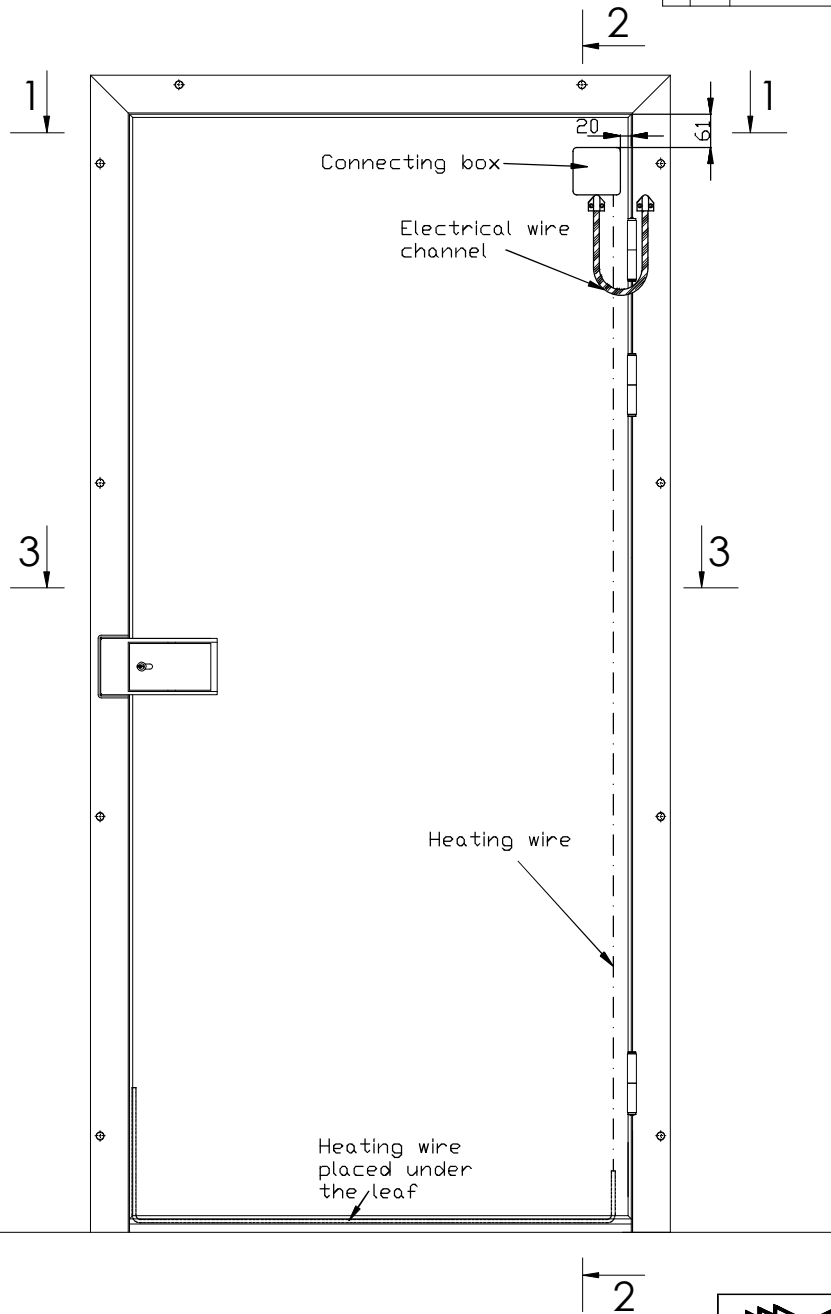
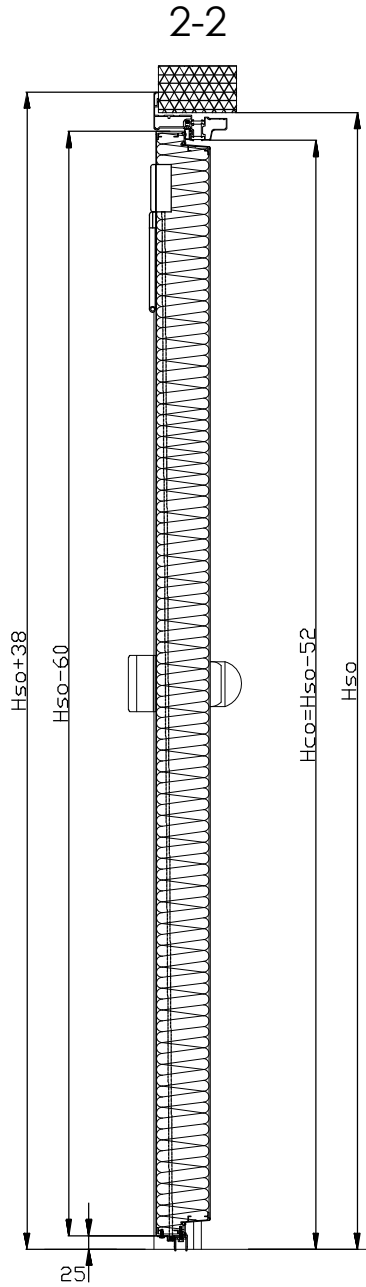

Contact address:  
**THERMOD AB**  
 Söderborgsvägen 32  
 SE-671 95 Klässbol, Sweden  
 tel. (0)570 72 74 70  
 fax. (0)570 72 74 71  
 info@thermod.se

Drawing name:  
 FD without threshold, one sided  
 cover, mounting for panel

Date: 03-03-2015  
 Drawn by: S.Kogut  
 Scale: 1:10

Drawing number:  
 030-031-00

Print format: A3  
 Revision: 03